



pure indoor living



*ULTRASONIC
HUMIDIFIER*

MODEL: BU6000-CN

Instruction Leaflet

Read instructions before operating. Retain for future reference.

 Questions? Comments? Call 1-800-253-2764 in North America or visit our website at www.bionairecanada.com.

PLEASE READ AND SAVE THESE IMPORTANT SAFETY INSTRUCTIONS

When using electrical appliances, basic safety precautions should always be followed to reduce the risk of fire, electric shock, and injury to persons, including the following:

1. Read all instructions before using the appliance.
2. To avoid fire or shock hazard, plug the appliance directly into a 120V AC electrical outlet.
3. Keep the cord out of heavy traffic areas. To avoid fire hazard, NEVER put the cord under rugs or near heat registers.
4. DO NOT place humidifier near heat sources such as stoves, radiators, and heaters. DO locate your humidifier on an inside wall near an electrical outlet. The humidifier should be at least 4 inches (10 cm) away from the wall for best results.
5. NEVER place humidifier in an area where it is accessible to children. NEVER use humidifier in a closed room, particularly where a child may be sleeping, resting, or playing (a closed room may result in excessive humidity).
6. **WARNING:** Do not attempt to refill humidifier without first unplugging the unit from its electrical outlet. Failure to heed this warning may cause personal injury. Be sure to unplug the unit by pulling on the plug and not the cord.
7. Never place anything over moisture outlet when the unit is running.
8. NEVER drop or insert any object into any openings.
9. DO NOT operate any appliance with a damaged cord or plug, after the appliance malfunctions, or if it has been dropped or damaged in any manner. Return appliance to manufacturer for examination, electrical or mechanical adjustment, or repair.
10. Use appliance only for intended household use as described in this manual. Any other use not recommended by the manufacturer may cause fire, electric shock, or injury to persons. The use of attachments not recommended or sold by the manufacturer may cause hazards.
11. DO NOT use outdoors.
12. Always place humidifier on a firm, flat, level surface. A waterproof mat or pad is recommended for use under the humidifier. NEVER place it on a rug or carpet, or on a finished floor that may be damaged by exposure to water or moisture.
13. DO NOT allow the Moisture Outlet to directly face the wall. Moisture could cause damage, particularly to wall paper.
14. Humidifier should be unplugged when not in use.
15. NEVER tilt, move, or attempt to empty unit while it is operating. Shut off and unplug before removing the water tank and moving the unit.
16. This humidifier requires daily and weekly maintenance to operate appropriately. Refer to daily and weekly cleaning procedures. Use only cleaners and additives recommended by the manufacturer.
17. NEVER use detergents, gasoline, glass cleaner, furniture polish, paint thinner, or other household solvents to clean any part of the humidifier.
18. Excessive humidity in a room can cause water condensation on windows and some furniture. If this happens, turn the humidifier OFF.
19. Do not use humidifier in an area where humidity level is in excess of 50%. Use a hygrometer, available at your local retailer or through the manufacturer, to measure the humidity.
20. DO NOT attempt to repair or adjust any electrical or mechanical functions on this unit. Doing so will void your warranty. The inside of the unit contains no user serviceable parts. All servicing should be performed by qualified personnel only.

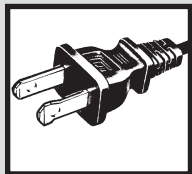

THIS APPLIANCE HAS A POLARIZED PLUG (one blade is wider than the other). To reduce the risk of electric shock, this plug is intended to fit in a polarized outlet only one way. If the plug does not fit fully in the outlet, reverse the plug. If it still does not fit, contact a qualified electrician to install the proper outlet.

DO NOT ATTEMPT TO MODIFY THIS PLUG OR DEFEAT THIS SAFETY FEATURE IN ANY WAY.

FEATURES - OPERATIONS

21. Never place housing under water flow or immerse in liquids.
22. Do not plug in the cord with wet hands: electric shock could result.
23. Do not pour water in any openings other than the water tank.
24. To prevent damage to surfaces, do not place humidifier under overhanging surfaces.
25. NEVER operate unit without water in the tank.
26. Do not move unit after it has been used until unit cools completely.
27. Use both hands when carrying full tank of water.

PLEASE READ AND SAVE THESE IMPORTANT SAFETY INSTRUCTIONS

CONSUMER SAFETY INFORMATION

NOTE: This is an electrical appliance and requires attention when in use.

NOTE: If moisture forms on the walls or windows of the room, turn off the humidifier. The room already has plenty of humidity and additional moisture may cause damage.

NOTE: DO NOT block air inlet or outlet.

Cord and Plug Installation Safety Instructions:

The length of cord used on this appliance was selected to reduce the hazards of becoming tangled in, or tripping over a longer cord. If a longer cord is necessary an approved extension cord may be used. The electrical rating of the extension cord must be equal to or greater than the rating of the humidifier (refer to the rating information placed on the humidifier). Care must be taken to arrange the extension cord so that it will not drape over the countertop or tabletop where it can be pulled on by children or accidentally tripped over.

ICES STATEMENT

This apparatus meets all requirements of the Canadian Interference-Causing Equipment Regulations. This Class B digital apparatus complies with Canadian ICES-001.

HOW ULTRASONIC WORKS:

An ultrasonic transducer atomizes water, producing refreshing visible cool mist.

NOTE: A humidity level below 20% can be unhealthy and uncomfortable. The recommended humidity level is between 40%-50%.

PRE-OPERATING INSTRUCTIONS

1. When using the humidifier for the first time after being removed from its original box, it is recommended to place the unit at room temperature for about 30 minutes before operation.
2. Select a location for your humidifier, on a flat surface, at least 4 inches (10 cm) away from the wall. DO NOT place the humidifier on a finished floor or near furniture, which can be damaged by too much moisture or water. Place on a moisture resistant surface.
3. Be sure the humidifier is disconnected from the electrical outlet and the unit control knob is switched to standby () position.

FILLING THE WATER TANK

WARNING: DO NOT pour water into the mist nozzle on top of the humidifier. DO NOT pour water directly into the water basin as this may cause damage to the unit. Always follow below steps to fill or refill water.



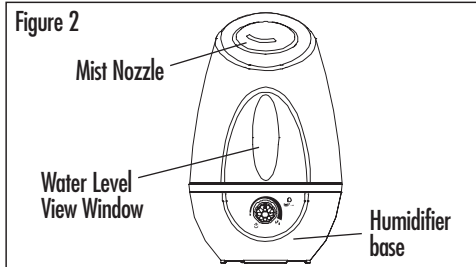
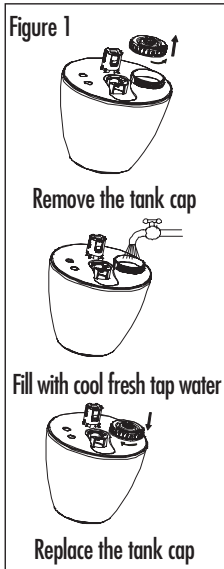

1. Shut off and unplug before removing the water tank and moving the unit. See Figure 4 for reference.

FEATURES - OPERATIONS

2. Bring the tank to the sink, turn upside down and twist off the tank cap by turning counter clockwise. Fill tank with cool, fresh tap water. DO NOT fill with warm water as this may cause the unit to leak. Place the cap back on tank and turn firmly clockwise to complete this step. See Figure 1 for reference.
3. Place tank back on to the base. The tank will immediately begin to release water into the base reservoir.
4. Make sure the water tank is well placed.
5. Plug the humidifier into the appropriate electrical outlet.



OPERATING INSTRUCTIONS

1. Rotate the control knob clockwise from the off position  to the position between Low  & High  mist range to start the humidifier. The indicator light will illuminate in green, and mist will disperse from top after a few seconds. See Figure 3 for reference.
2. Adjust the control knob to select desired mist output level. Rotate knob clockwise to increase mist output level and counter clockwise to decrease mist level.
Note: High setting will produce the maximum moisture level and Low setting will produce the longest run time and quieter performance. When the humidifier runs out of water, the transducer and fan will automatically shut off.
3. To stop mist output at any setting, turn the knob counter clockwise to the off position .
4. When the humidifier runs out of water, the transducer and fan will automatically shut off. The indicator light will turn red. Turn the humidifier off and unplug it from the electrical outlet.

Before refilling, empty any residual water from the base and the tank (follow the "Daily Maintenance" instructions). Then follow the Filling Water Tank Instructions to refill the tank and put back into the humidifier to begin operation.

WARNING: DO NOT move the humidifier with water in the tank or the humidifier base. The moving action of the water may activate the water tank's release nozzle and overflow the humidifier base. This may cause the humidifier to function intermittently, or stop emitting mist. If this occurs, simply remove the excess water from the humidifier base.

LED Night Light

Your humidifier is equipped with blue decorative night light feature. Built-in night-light in humidifier base, below the water tank base, illuminates the water with a blue light, which can be seen through the water level view window. The decorative light will turn on when the control knob rotates clockwise into Low to High mist position, and turns off when the control knob is placed into Standby position.

NOTE: DO NOT operate the humidifier without water.

CLEANING / MAINTENANCE

Figure 3: Control Panel

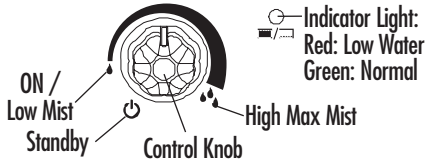
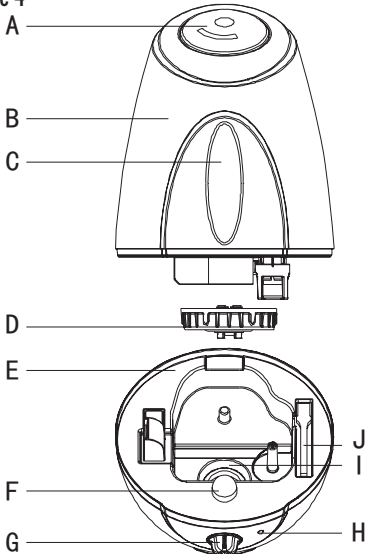

Figure 4



- | | |
|----------------------|------------------------------------|
| A. Mist nozzle | G. Control Knob |
| B. Water Tank | H. Power/Low Water Indicator Light |
| C. Water View Window | I. Transducer |
| D. Water Tank Cap | J. Cleaning Brush |
| E. Humidifier Base | |
| F. LED Night Light | |

CLEANING AND MAINTENANCE INSTRUCTIONS

Humidifiers provide comfort by adding moisture to dry, heated indoor air. To benefit most from the humidifier and avoid product misuse, follow all instructions carefully. Please note that this is an electrical appliance and requires attention when in use.

In addition, if you do not follow the recommended care and maintenance guidelines, micro-organisms may be able to grow in the water within the water tank. You must routinely follow the cleaning procedures that follow in order to ensure proper, efficient operation of your humidifier. Proper maintenance and cleaning is essential to the continued performance of your unit and the avoidance of algae or bacteria build-up.

Daily Maintenance:

1. Be sure the unit is OFF and is disconnected from the electrical outlet.
2. Remove the tank from the base of the unit, drain and rinse the base and tank thoroughly to remove any sediment or dirt. Wipe clean, and dry with a clean cloth or paper towel.
3. Refill tank with cool tap water as instructed earlier in the Filling Instructions. Do not overfill.
4. Follow Operating Instructions to turn on the humidifier.

Weekly Maintenance:

To Remove Scale:

1. Repeat previous steps in Daily Maintenance.
2. Clean the base by partially filling the base with one 8-oz cup of undiluted white vinegar. Leave this solution in the base for 20 minutes, while cleaning all the interior surfaces with a soft brush (brush included). Gently scrub the area around the transducer with a soft brush. Remove base scale by wiping the base with a cloth dampened with undiluted white vinegar.
3. Rinse with clean warm water to remove the cleaning solution before disinfecting the tank.

TROUBLESHOOTING

To Disinfect Humidifier Base and Tank:

1. Fill humidifier tank 1/2 full with water and 1/2 tablespoon of chlorine bleach.
2. Let the solution stand for 20 minutes, swishing every few minutes. Wet all surfaces.
3. Carefully empty the tank after 20 minutes, and rinse with warm water until you cannot detect any bleach smell. Dry with a clean cloth or paper towel.
4. Refill the water tank with cool water and replace on unit (see Filling Instructions above). Follow Operating Instructions to turn the humidifier ON.
5. To clean the humidifier base, pour out all excess water. Wipe clean and dry with a clean cloth or paper towel. Do not use metal cleaning utensils or abrasive cleansers.

STORAGE INSTRUCTIONS

When not using your humidifier for an extended period of time:

1. Clean, rinse and thoroughly dry the humidifier as directed in weekly maintenance. DO NOT leave any water in the unit when storing. Leaving water in the unit may render the unit inoperable for the following season.
2. Place the humidifier in the original carton and store in a cool, dry place.

REPLACEMENT ACCESSORIES

To order the replacement accessories you can do any of the following:

- Visit your local retailer
- Go to www.bionairecanada.com.
- Call Consumer Service at 1-800-253-2764.

TROUBLESHOOTING

Problem	Cause	Solution
<ul style="list-style-type: none">• There is not enough mist.	<ul style="list-style-type: none">☛ The Mist Control is on the Lo [▲] Setting☛ Resonance from the surface bearing the unit☛ Scale covers the transducer. ☛ The water is too dirty or the water in the tanks has been kept there too long, so it's not fresh.	<ul style="list-style-type: none">✓ Change the Mist Control to Hi ^{▲▲} Setting (see Mist Control instructions)✓ Place the unit on a steady surface or on the ground.✓ Clean the transducer softly with a damp cotton ball. Transducer surface is delicate, avoid applying excessive pressure.✓ Clean the water tank, change to fresh, clean water.
<ul style="list-style-type: none">• Mist has bad odour.	<ul style="list-style-type: none">☛ The machine is new or the water is not clean.	<ul style="list-style-type: none">✓ Open the water tank and place the appliance in a cool area for 12 hours. Wash the tank out or change the water.
<ul style="list-style-type: none">• Abnormal noise	<ul style="list-style-type: none">☛ Resonance effect due to too little water in the water tank.☛ Resonance from the surface bearing the unit.	<ul style="list-style-type: none">✓ Refill water in the water tank.✓ Place the unit on a steady surface or on the ground.

FREQUENTLY ASKED QUESTIONS

FREQUENTLY ASKED QUESTIONS

Question	Answer
• What are the variables that affect run time?	<p>The estimated run time for this humidifier is based on average room conditions. The actual run time of your humidifier is dependent on numerous variables such as:</p> <ul style="list-style-type: none">✓ Air exchange in the room where the humidifier is placed.✓ Room construction of the room where the humidifier is placed.✓ Temperature of the room where the humidifier is placed.✓ Humidity levels in the room where the humidifier is placed.✓ Movement of occupants and the opening and closing of doors in the room where the humidifier is placed.✓ Home furnishings in the room where the humidifier is placed.
• How do I remove film on water tank?	✓ See Daily Maintenance instructions. Regular cleaning is recommended.
• How can I extend the run time?	<ul style="list-style-type: none">✓ Run your unit on the lowest setting.✓ If your unit has electronics, set it to your desired humidity level. The unit will turn on and off, which will extend the run time.✓ Fill the tank all the way full, place it on the base, let the water empty into the base until it stops bubbling, then refill the tank full again. This ensures maximum water capacity and will extend run time.

If you have any questions regarding your product or would like to learn more about other Bionaire® products, please contact our Consumer Service Department at 1-800-253-2764 or visit our website at www.bionairecanada.com.

WARRANTY INFORMATION

1 YEAR LIMITED WARRANTY

Sunbeam Products, Inc. doing business as Jarden Consumer Solutions or if in Canada, Sunbeam Corporation (Canada) Limited doing business as Jarden Consumer Solutions (collectively "JCS") warrants that for a period of one year from the date of purchase, this product will be free from defects in material and workmanship. JCS, at its option, will repair or replace this product or any component of the product found to be defective during the warranty period.

Replacement will be made with a new or remanufactured product or component. If the product is no longer available, replacement may be made with a similar product of equal or greater value. This is your exclusive warranty. Do NOT attempt to repair or adjust any electrical or mechanical functions on this product. Doing so will void this warranty.

This warranty is valid for the original retail purchaser from the date of initial retail purchase and is not transferable. Keep the original sales receipt. Proof of purchase is required to obtain warranty performance. JCS dealers, service centers, or retail stores selling JCS products do not have the right to alter, modify or any way change the terms and conditions of this warranty.

This warranty does not cover normal wear of parts or damage resulting from any of the following: negligent use or misuse of the product, use on improper voltage or current, use contrary to the operating instructions, disassembly, repair or alteration by anyone other than JCS or an authorized JCS service center. Further, the warranty does not cover: Acts of God, such as fire, flood, hurricanes and tornadoes.

What are the limits on JCS's Liability?

JCS shall not be liable for any incidental or consequential damages caused by the breach of any express, implied or statutory warranty or condition.

Except to the extent prohibited by applicable law, any implied warranty or condition of merchantability or fitness for a particular purpose is limited in duration to the duration of the above warranty.

JCS disclaims all other warranties, conditions or representations, express, implied, statutory or otherwise.

JCS shall not be liable for any damages of any kind resulting from the purchase, use or misuse of, or inability to use the product including incidental, special, consequential or similar damages or loss of profits, or for any breach of contract, fundamental or otherwise, or for any claim brought against purchaser by any other party.

Some provinces, states or jurisdictions do not allow the exclusion or limitation of incidental or consequential damages or limitations on how long an implied warranty lasts, so the above limitations or exclusion may not apply to you.

This warranty gives you specific legal rights, and you may also have other rights that vary from province to province, state to state or jurisdiction to jurisdiction.

How to Obtain Warranty Service

In the U.S.A.

If you have any question regarding this warranty or would like to obtain warranty service, please call 1-800-253-2764 and a convenient service center address will be provided to you.

In Canada

If you have any question regarding this warranty or would like to obtain warranty service, please call 1-800-253-2764 and a convenient service center address will be provided to you.

In the U.S.A., this warranty is offered by Sunbeam Products, Inc. doing business as Jarden Consumer Solutions located in Boca Raton, Florida 33431. In Canada, this warranty is offered by Sunbeam Corporation (Canada) Limited doing business as Jarden Consumer Solutions, located at 20 B Hereford Street, Brampton, Ontario L6Y 0M1. If you have any other problem or claim in connection with this product, please write our Consumer Service Department. **PLEASE DO NOT RETURN THIS PRODUCT TO ANY OF THESE ADDRESSES OR TO THE PLACE OF PURCHASE.**